

3 person infrared sauna Pavillon – 1633x1078x1940

User Manual

Note: Room must be installed on flat, level surface.

Precautions Before Use	2
Preassembly Information	2
Electrical Requirements	3
Sauna Assembly	4
Electrical Connection-Under Bench	8
Electrical Connection-Inside Ceiling	13
Control Panel Instructions	16
Lighting Operation	17
Audio System	17
How to Use Sauna	19
Tips & Troubleshooting	20
Wiring Diagram	21

Precautions before Use: Warning (Room Configuration & Use):

- Proper Electrical Grounding is Required
- Electrical Receptacles not Allowed in the Room
- Do not Apply Water to any Heating Element
- Do not Add a Locking or Latching System to the Door
- Do not Block Ventilation Openings
- Children Must be Supervised at all Times in the Sauna

Electrical Caution – Do not plug the room power cord into an electrical outlet until Room Assembly is completed!

a. Warning (Human Limitations):

Prolonged Exposure at Elevated Temperatures May Cause Hyperthermia (Body Temperature is Several Degrees Above 37°C (98.6°F))

Hyperthermia Symptoms include: Dizziness, Lethargy, Drowsiness, and Fainting

Hyperthermia can cause:

- Fetal Damage in Pregnant Women
- Physical In-Ability to Exit the Room
- Loss of Consciousness

Notice - Use of Alcohol or Drugs Increases the Risk of Fatal Hyperthermia

If You Have any Health Problems or Health Conditions, Consult Your Physician Prior to Sauna Use, Discontinue Use if Nervousness, Tremor, Headache, Feeling of Sickness or Nausea Occurs

b. Warning (Fire Hazards):

- Do Not Use the Sauna Room for Drying Cloths, Bathing Suits, Etc.
- Do Not Hang Towels or Other Objects on Heater Grills
- Never Operate this Sauna Room if it Has a Damaged Cord or Plug

Pre-assembly Information:

- a. Two (2) adults are required for the assembly and installation of the room.
- b. Assembly Tools: Phillips Screw Driver
- c. Boxes are labeled in the order of room assembly
- d. Note: Front wall glass assembly is heavy and fragile.

Box #1: Floor, Ceiling, Bench Skirt, Bench, Manual & Door Handle Set

Box #2: Left & Right Walls

Box #3: Front & Back Walls

Electrical Requirements: The IR Sauna Room is designed for a 230 Volt AC / 10 Amp Circuit Breaker!
A 230 Volt AC (dedicated) circuit is recommended to avoid unnecessary tripping of the breaker.

Record your model number and serial number in the event you should need to contact your dealer or technical support.



Serial Number _____

Model Number _____

Dealer Name _____

Sauna Assembly Instructions

Floor Panel (Box #1):

- Locate the Floor Panel on a level surface 8-15 cm (3-6 inches) from wall and no more than 150 cm (5 ft) from 230 Volt AC / 10 amp dedicated receptacle.
- Position the Floor panel so that the Ceramic tiles / IR Floor Heaters are to the front of the room

Note: place the Ceiling, Bench Skirt and Bench to the side until the appropriate steps.



Note: place the power cord on the ground to the side of the floor; be sure that all wires and connectors on the sauna floor are clear of the slots.



Note – Do NOT Plug the Sauna Room 230 VAC Power Cord into the Outlet Yet!

Back Wall (Box #3):

*Note: after opening box 3 -- store Front Wall panel until that step of the assembly process.
Be sure to control the door from opening when moving the Front Wall Panel to prevent breakage.*



- Place Back Wall panel into the back slot of the Floor Panel.
- Back Wall panel must be held in place until the Right Wall panel is added.



Right Wall (Box #2):

- Place Right Wall section into the right slot of the Floor Panel
- Attach Back Wall to the Right Wall by lifting up the Right wall sliding into the corner interlock brackets.



Left Wall (Box #2):

- Place Left Wall section into the left slot of the Floor Panel
- Attach the Back Wall to the Left Wall by lifting up the left wall sliding into the corner interlock brackets.



Note: When wall panels are connected in place properly the corners will be level and flush on top.

Bench Skirt (Box #1):

- Insert the Bench Skirt in between the Right Wall and the Left Wall panels tracks.
- Slide Bench Skirt all the way to the floor. Do not pinch any wires under the skirt.
- Latch the buckles securing the floor to the Bench Skirt. **Do not** latch the buckles for the left and right wall panel at this time.



Bench Top (Box #1):

- Slide the Bench seat down against the back wall with Power Junction Box facing you.
- Tilt the Bench against the Back Wall so it will remain standing.



Electrical Connections (under bench - right side):

- Connect wire #4 from distribution plate to #4 from Back Wall harness.
- Connect wire #5 from the distribution plate to #5 from the Back Wall harness.



- Connect wire R1 from the distribution plate to R1 from the Right Wall junction box.



- Connect wire S3 from the distribution plate to S3 from the Bench Skirt.
- Connect wire #6 from the Back Wall harness to the Bench Skirt wire #6.
- Connect wire S1 from the distribution plate to the Bench Top wire S1.



Electrical Connections (under bench - left side):

- Connect wire L1 from the distribution plate to L1 from the Left Wall panel.
- Connect wire B1 from the distribution plate to B1 from the Back Wall panel.



- View of the finished connections.



- Locate the electrical switch on the black Master Control Box and ensure the switch is on.

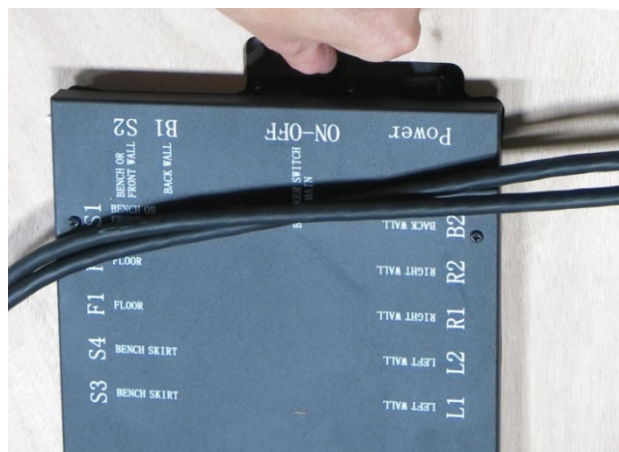

- Use the buckles to latch the skirt to the left and right side walls.



- Bench top can now be fit into place. Bench must tuck under the back heater guard and then push all the way to the back wall.
- The Bench Top should fit down flush from front to back. It may be necessary to use the openings in the skirt to apply pressure forward or rearward on the skirt to allow the bench to drop into place.



Ceiling (Box #1):

- Install 4 large Styrofoam packing squares on top of the Right & Left Wall panels. One block should be placed in the front portion and one toward the rear portion of each wall. These will be used to set the ceiling on.
- The ceiling can now be set in place on top of the Styrofoam blocks.



- Once the Ceiling panel is lined up directly above the Wall panels; insert the wires harnesses from the wall panels into the holes in the Ceiling panel.



Note: Position the cam locks on the top of the Left & Right Wall panels as shown above.

- Lower the Ceiling panel by removing the rear Styrofoam blocks first and leaving the front blocks until front wall installed. **Be sure not to pinch any wires under the Ceiling panel.**



Front Wall (Box #2):

- Start with the door and glass panel piece and move to the Floor panel slot.
- Place the Front Wall panel into the Floor panel slot.
- Have one person hold the door and glass panel, while another brings the last glass panel.
- While the left front glass piece is positioned, open the door to allow more work space.



Note: Secure the door from falling open and breaking while setting the Front Wall panel. It may be helpful to use your knee to help push in the Front Wall panel while lowering into place.

- Remove the foam blocks on the front corners, and place the glass panels in the slots in the ceiling. Make sure the ceiling fits tight and is flat and level.
- Turn the wood ceiling cam locks to lock the ceiling into place.

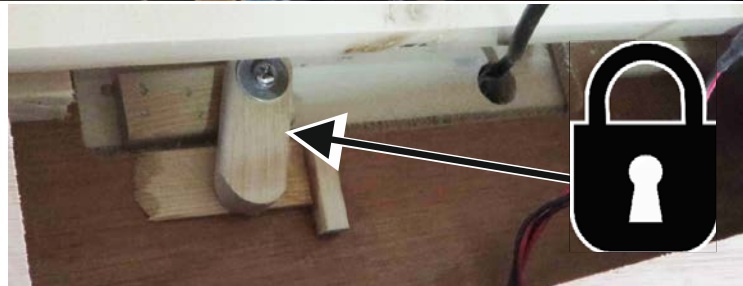

Electrical Connections (inside the Ceiling panel-back right corner):

- Open all hatch doors on the ceiling to locate the necessary electrical plugs.
- Access the connectors and connect them according to the labels on the harness.
- Connect wire #4 from the Back Wall harness to the Ceiling wire #4.
- Connect wire #5 from the Back Wall harness to the Ceiling wire #5.
- Connect wire #6 from the Back Wall harness to the Ceiling wire #6.

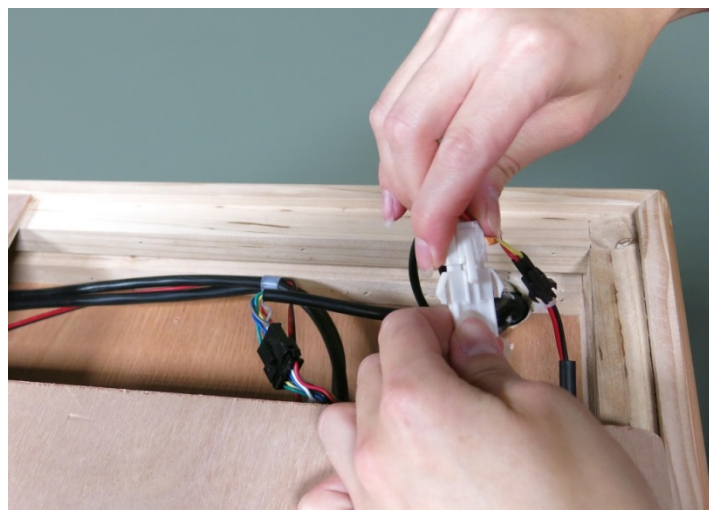

Electrical Connections (inside Ceiling-Left front corner):

- Near the Touch Screen harness in Ceiling connect Left Wall wire #3 to Ceiling wire #3.
- Connect Left Wall wire #7 to the Ceiling wire #7.
- Connect Left Wall wire F to Ceiling wire F.
- Connect Left Wall wire E to Ceiling wire E.

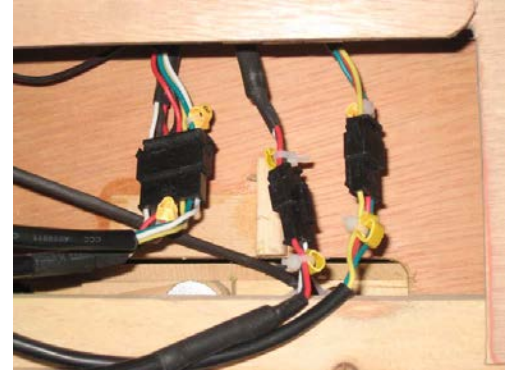

Electrical Connections (inside Ceiling-Left rear corner-not pictured):

- Connect the Right wall wire #7 to Ceiling #7 for valance lights.

Electrical Connections (inside the Ceiling-Right front corner):

- Connect the Right wall wire #7 to Ceiling #7 for valance lights.

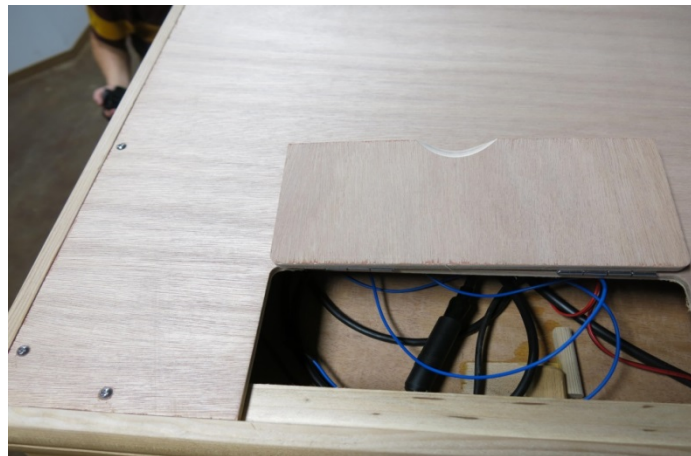

Sauna Room 230 Volt AC Power Cord:

- Plug the Sauna room power cord into the 10 amp wall receptacle as noted in page 3

Note: It is important that the sauna be plugged into a dedicated outlet of the correct rating. Plugging your sauna into a shared circuit through can cause poor performance, circuit breaker tripping, or overheating of the circuit.

Door handles:

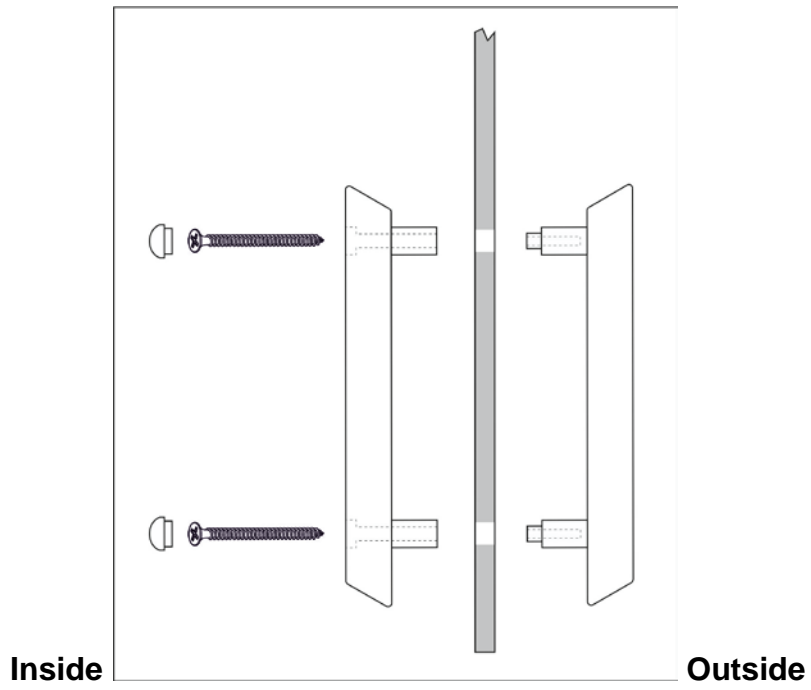
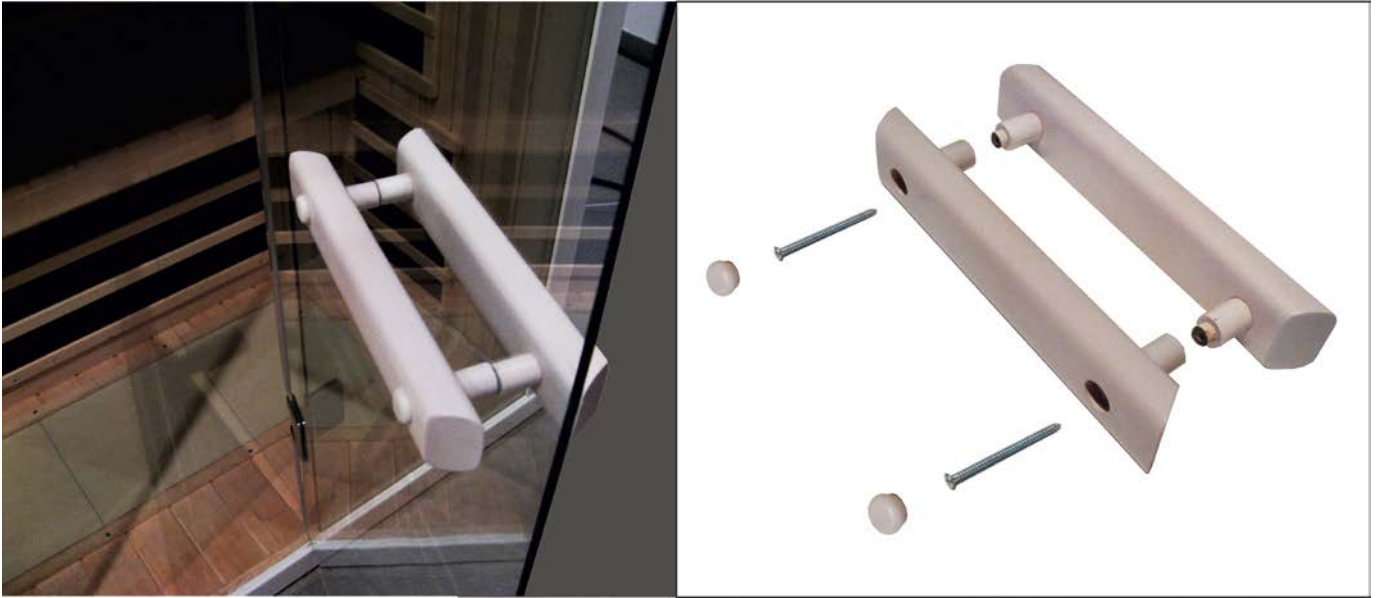

The Sauna Rooms is now ready to use!

Control Panel Instructions:

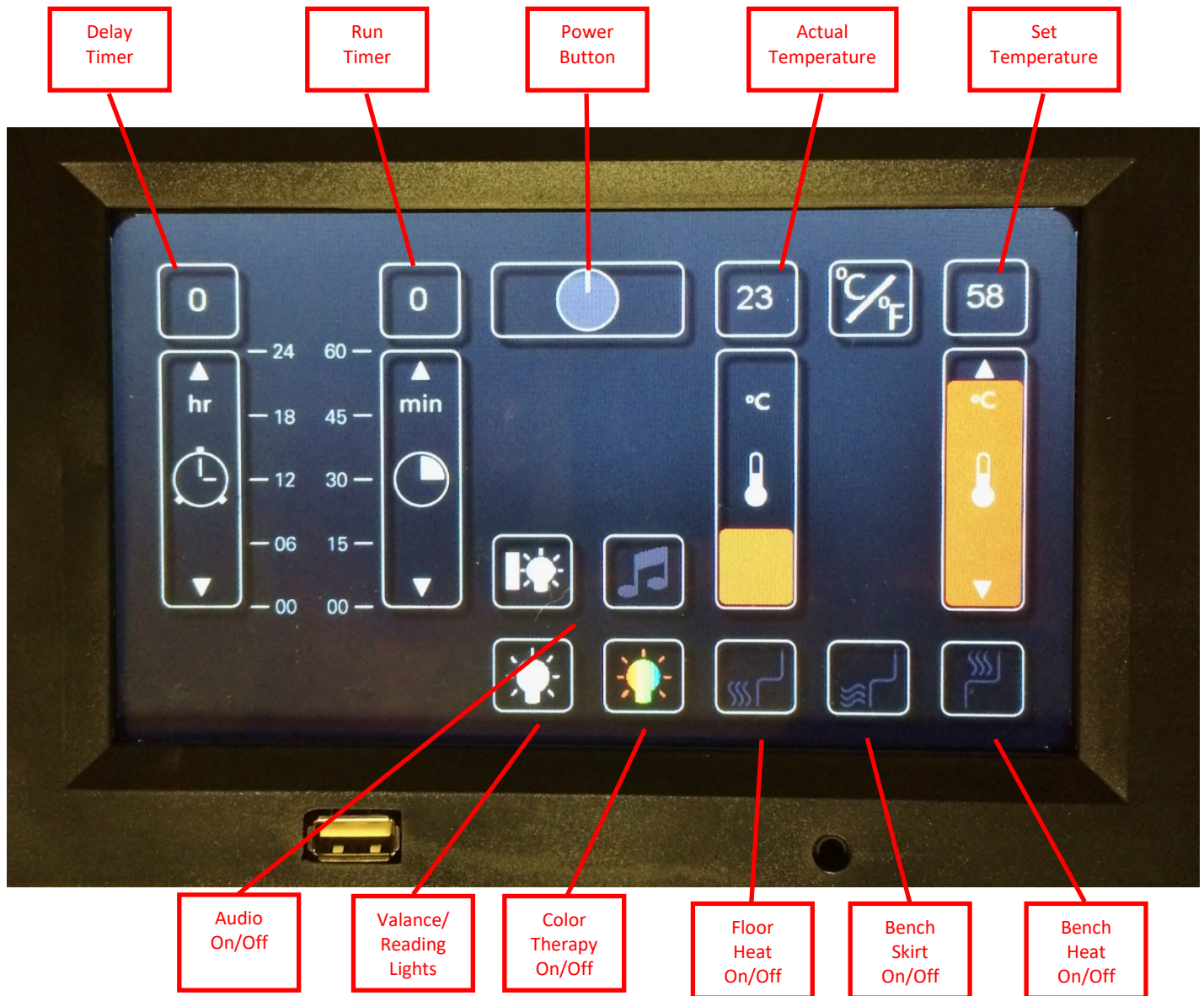

Main Power: Press **POWER** button in the upper middle portion of the screen. When lit red, control is **ON**. When white, control is **OFF**.

Timer Functions: Press and hold ▲ or ▼ to set room run time. You may also slide your finger up and down to move timer.

Delay Timer #1:  To preset sauna to come on later, use feature up to 24 hours for desired time delay.

Temperature Functions:

1. Press to alternate between either **C** or **F** C or F will light to indicate the units desired
2. Press and hold ▲ or ▼ to set desired room temperature setting. Pressing once will increase or decrease the desired setting in one-degree increments. You may also slide the temperature bar with your finger.

Actual temperature readout shows temperature in the room.

3. Press to turn **Bench/Leg/Floor Heat ON** or **OFF**. Waves will show red in heating mode; white when in **OFF** mode. If left on the waves will cycle on/off as the room reaches the set temperature

Light Functions:

1. Press “Valance/Reading button” to turn **ON** or **OFF**
2. Note: “Outside Light” **ON** or **OFF** will not be functional on “S” series models.

Color Therapy Functions:

Press “Color Therapy Light” to activate a color light or sequence. The following details this sequence:

- 1st press – RED
- 2nd press – RED-GREEN
- 3rd press – GREEN
- 4th press – BLUE-GREEN
- 5th press – BLUE
- 6th press – BLUE-RED
- 7th press – BLUE-RED-GREEN
- 8th press – Activates full rotation of all 7 color therapy in sequence noted above
- 9th press – Turns Color Therapy Functions OFF

In addition at any point in the color sequence if you hold the control button down for 3 seconds it will turn the color lights OFF

Note: The color of light is depicted in the waves around the bulb symbol.

Screen Saver Mode:

The Sauna Control screen has an automatic screen saver built in to it. If left untouched the display will switch to a series of pictures that will change automatically. The remaining run time and room temperature will still be displayed over the picture. When the timer runs out completely, the Touch Screen will go completely dark after a preset amount of time.

Audio System Operations:

Press “Music Note” to access the Audio Screen.

BLUETOOTH (Press Bluetooth icon)

To pair a device, go to source device (phone or some other device with Bluetooth) and search for Bluetooth devices. The searching device should find a new device (example CSR8670-HZXT) and press pair. Device should say paired after a few seconds. The source device and the touch screen will control the volume control.

AUXILIARY INPUT

Plug in a 3.5 mm cable into the control of the room and select AUX icon. Turn on the input from a source device (smart phone or some other audio source) to hear the sound. The source device and the touch screen will control the volume control.

Note: 3.5 mm cable not included with the room



USB

Press “USB” icon and insert USB storage device for MP3, The volume will be controlled by the touch screen. Some versions of MP3 or other audio files may not play in USB Port.

For Apple products, you will need to use a 3.5mm audio cable from your device to the control. Do not use the USB port for Apple devices; it is not possible to control your Apple device with the Sauna Control Panel.

Note: Temperatures within the Sauna are high. Ensure that your electronic device will not be damaged by these air temperatures. We do not warrant any such damage to electronic audio devices.



After a few seconds the Audio screen will automatically go back to the Sauna Control screen. You will now see an icon in the middle of your screen displaying the audio function that is still operating in the Audio screen.

How to Use Infrared Sauna:

Avoid eating large meals and excessive alcohol intake before using Sauna.

Never smoke or drink alcohol or exercise inside of Sauna.

If you are taking any medications or under the care of a Physician, consult with them prior to Sauna usage.

Refer to Sauna Usage Warning signs located inside of Sauna Room

Prior to Sauna session, if possible before using Sauna, take a warm shower without drying.

Clothing is optional or wear loose fitting clothes. You may choose to sit or lie on a clean soft towel.

Set desired time & temperature.

The Sauna is producing the correct wavelengths to be absorbed into the body within 10-15 minutes of operation. It is not necessary to wait until the sauna is at maximum temperature, the absorption of wavelength is the same whether the room is in heat up or at set temperature.

Enter Sauna and relax, you may choose to enjoy music. Refer to the above Color Therapy System instructions.

Sit or lie on bench. Close the door and open the interior ceiling vent allowing for fresh air circulation.

Remain in the Sauna long enough to warm up and stimulate a mild perspiration. Typically that may occur in 10 – 15 minutes. This varies with every individual and their comfort level. Do not over do it!

Drink plenty of cool water or a refreshing healthy drink while using the sauna.

Leave the Sauna and cool down. Shower or bathe if possible to cool down and cleanse the skin.

Cool down period usually is the same length of time as the Sauna session.

Then reenter the Sauna for another 10-15 minute session.

Continue this process of alternating using the Sauna and Cooling Down for 3 to 4 cycles.

Length of time in the Sauna and cool off period varies and depends on the individual.

After final Sauna session and upon leaving the Sauna turn the Sauna off the timer if it is still operating.

Open the door and clean the Sauna walls, bench and floor areas with a soft clean damp cloth.

Enjoy a final shower or bath to cool down. Relax, in the special “after sauna glow” and you may choose to enjoy a healthy snack and cool drink.

Additional Usage Warnings Located Inside Sauna Room



Tips:

DO NOT USE: Alcohol or any strong Cleaning Chemicals

Note: Some chemicals can damage clear finish and wood surfaces.

- Interior: Perspiration and dirt may absorb into the wood, so periodic cleaning is needed, scrubbing benches, back supports, floor boards and walls with a stiff brush and mild detergent is normally sufficient. Light sanding is another option for cleaning interior surfaces.
- Exterior: Use a damp cloth of a mild soap mixed with warm water.
-

Trouble Shooting Tips:

a. Main Control Touch Pad Lights Not Lit:

- Ensure electrical connections between ceiling and back and the ceiling and front wall
- Ensure power cord is plugged in to the proper power receptacle and dedicated circuit breaker
- Ensure main circuit breaker (house) is not tripped (power is found at the receptacle)
- Ensure the room main controller circuit breaker (under the bench) is not tripped and is ON

b. Room not heating:

- Ensure power cord is plugged in to the power receptacle
- Ensure main circuit breaker (house) is not tripped (power is found at the receptacle)
- Ensure the room main controller circuit breaker (under the bench) is not tripped and is ON
- Ensure room desired temperature is greater than room actual temperature (controller demands heat)
- Ensure that there is no time in the Delay Start timer if you do want to delay the start

c. Door rubbing or binding:

- Ensure that the room is assembled properly; walls and ceiling should all be interlocked.
- Ensure the floor is flat by using a level on the ceiling of the room. It may be necessary to use a small door or window shim to adjust the level under the floor.



IR Room Wiring Diagram
- Bluetooth Audio System -
(SH Series 230VAC)

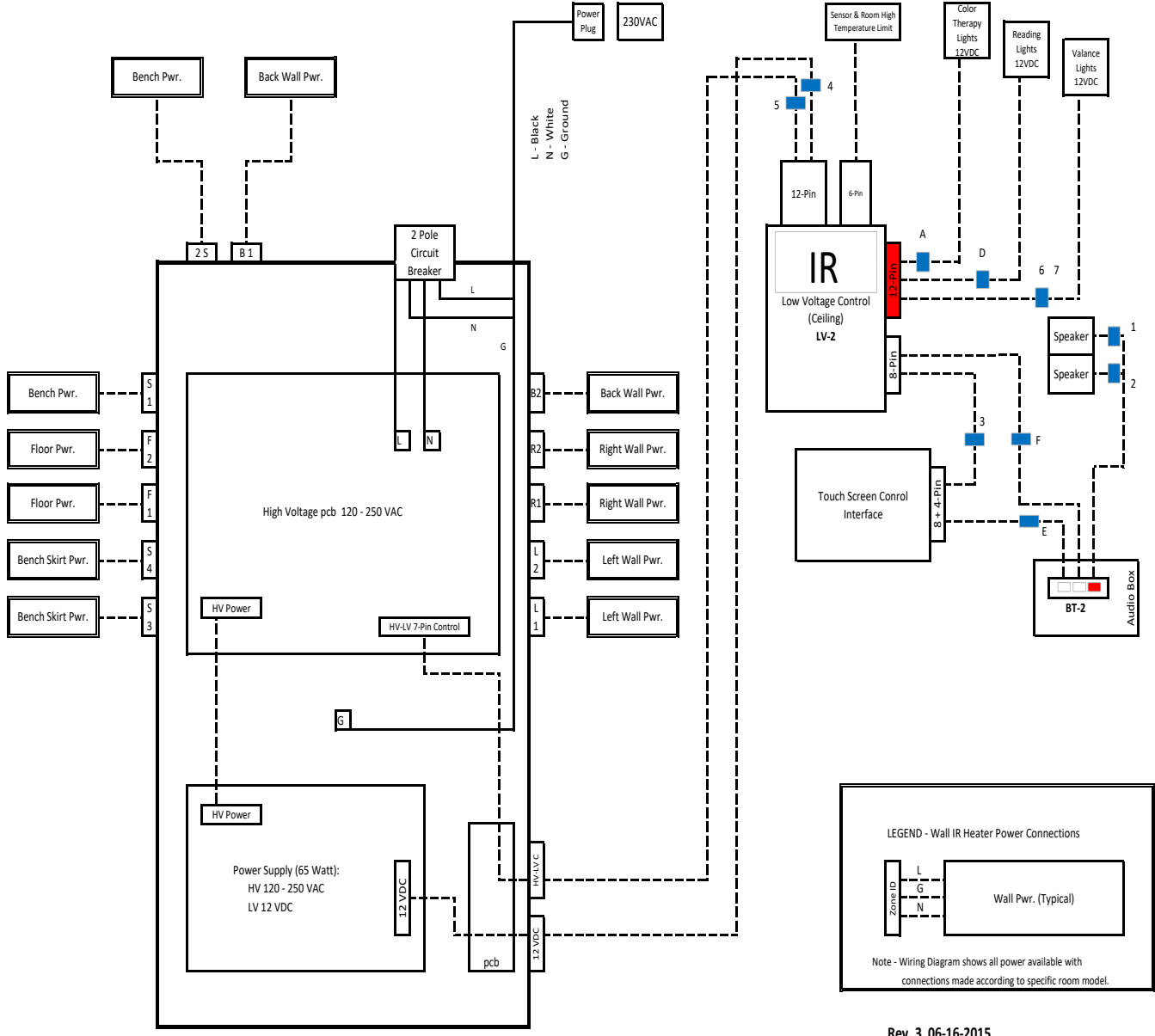

Rev. 3 06-16-2015

